



- flexible
- reliable
- reasonably priced



Tooling Pricelist





Priceliste 09/06-T

Pricelist valid from 01.09.06

Replace the list 10/04 from 1.10.2004

- Delivery ex Work - unpacked
- Amada toolings for all machine available

Machine groups Boschert

MP 25	KST 25 KST 40 KST CNC KST 20/450 (Kunz) KST 20 Mini (Kunz)	PL manuell + digital PL CNC PL CNC Z	EL manuell + digital EL CNC EL CNC Z	TWIN TRI	Evolution Compact Combicut	Tiger LB 13 Quick
-------	--	--	--	-------------	----------------------------------	----------------------

Machine groups Trumpf

A	B	C	D	E	F	G	H ***	S	I ***
CN 700	CN 901E	CN 1200S	TRUMATIC	SUNIMAT 400	TRUMATIC	TRUMATIC	TRUMATIC	TRUMATIC	TRUMATIC
CN 900	CN 902	CN 1200A	20	Trumatic Trumatic	150W	20aW	500R	100	2000R
CN 701	CS 75	CS 15	20a	150K 202K	152W	202W	200R	120R	2020R
CN 901	CSCS 75.2	CS 20	202M	151K 225K	180W	300W	600L	160R	3000L
		CS 20a		152K 235K	180.2W	300LW	190R		3000R
		MP 25		180K 300K	180R	300PW			5000R
		MP25D		180.2K 300LK	180.2LW	300top			6000L
				180KD 300PK	180.LW	400W			
				180LK 400K	ELX/SWIFT				
				180.2LK	185				
					240				
					240R				
					250				
					260R				

*** Strippers for machine group H differ from those for other machine groups with regard to shape and size.
Please ensure that you use the strippers required for machine group H, with upward shear.



Table of Content:

Standard-Round Tools size I; II; III	4-5
Standard-Square Tools size I; II; III	6-7
Standard-Rectangle Tools size I; II; III.....	8-9
Standard-Oblong Tools size I; II; III.....	10-11
Standard-Special Shape SF 1 - SF 17	12-19
PU-Stripper	20
Revotool	21-23
Fully guided tools	24-25
Adjusting Rings	26-27
PASS-FIT-System	28
Punch chucks and Adapter Rings.....	29-31
Prick-Punch marking tool	32-35
Slitting Tools with springs	36-41
Slotting tooling size II	42-43
Compensating rings / polished Toos / punch adjustment unit	44-46
Adapter Ring with brushes.....	47
TICN - Coating and T-max Coating for punches	48
Revotool-Information.....	49-56
Tool Grinding Machine EASY - SHARP	57-58
Extrusion Tool upform Size II / Thread versioning Tool upform Size II	60-61
Counter Sink Tool downform Size I / Emboss Counter Sink Tool Size II.....	62-63
Louver Tool Size II upform / Continuous Louver Tool Size II	64-65
Beading Tool / Continuous Beading Tool / Offset Tool / Bending Tool	66-69
Dimple Tool Size I / upward	70
Half Shear Tool Size II / upform	71
Letter Marking Tool downform and upform / Ground Symbol Marking Tool	72-75
Round Emboss Tool Size II / upform	76
Hinge Tool Set Size II / upform	77
Fully giuded cluster tool / Lance and Form tool / Knock out tool / Bridge tool.....	78-81
Personal Notes.....	82-83

Pricelist 09/06-T

Standard Tools
Round

System

TRUMPF



BOSCHERT

GmbH&Co.KG

D-79523 Lörrach, Postfach 7042

Germany

Telefon + 49 7621 9593-0

Telefax + 49 7621 55184

<http://www.boschert.de>

e-mail: infoak@boschert.de

Punch

		HSS / Flat / 34,3 mm long		HSS / Flat / 37,8 mm long***		HSS / Whisper / 37,3 mm long	
Size	dim. „d“ in mm	Pos.-No.	Price in €	Pos.-No.	Price in €	Pos.-No.	Price in €
0/A	1,00-6,00	107A01		107A11			
0/B <small>(shaft 10,5)</small>	1,00-6,00	107C01		107C11			
0/B	6,01-10,50	107B01		107B11			
I	1,00-30,50	101111		103111		102111	
I/II	30,51-38,00	1012M1				1022M1	
II	30,51-40,00	101211		103211		102211	
	40,01-50,80	101221		103221		102221	
	50,81-60,00	101231		103231		102231	
	60,01-72,00	101241		103241		102241	
	72,01-76,20	101251		103251		102251	
III	76,21-105,00	101311				102311	
reinforced version	-30,50	108111		108311		108211	
	-40,00	108121		108321		108221	
	-76,20	1081-1		1083-1		1082-1	

Pricelist 09/06-T

Standard Tools
Round

System

TRUMPF



BOSCHERT

GmbH&Co.KG

D-79523 Lörrach, Postfach 7042

Germany

Telefon + 49 7621 9593-0

Telefax + 49 7621 55184

<http://www.boschert.de>

e-mail: infoak@boschert.de

Stripper

	Size	dim. „d“ in mm	machine group	Pos.-No.	Price in €
	II	-78,00	E / F / Boschert	110211	
		-78,00	A-D / G	111211	
		-78,00	H / I	112211	
	III	-107,00	Rota / Index	110211-1	
-107,00		C / D / Boschert	111311		
(I/II)	-41,00	S	1501M1		

Die

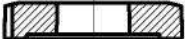
	Size	dim. „d“ in mm	HWS		HSS	
			Pos.-No.	Price in €	Pos.-No.	Price in €
	I	-32,00	106111		105111	
	I/II	-32,00	1061M1		1051M1	
	II	-77,00	106211		105211	
	III	-107,00	106311			
	reinforced version	-32,00	109111			
		-42,00	109221			
-62,00		109231				

Pricelist 09/06-T

Standard Tools
Square

System

TRUMPF



BOSCHERT

GmbH&Co.KG

D-79523 Lörrach, Postfach 7042

Germany

Telefon + 49 7621 9593-0

Telefax + 49 7621 55184

<http://www.boschert.de>

e-mail: infoak@boschert.de

Punch

		HSS / Flat / 34,3 mm long		HSS / Flat / 37,8 mm long***		HSS / Whisper / 37,3 mm long	
Size	dim. „a“ in mm	Pos.-No.	Price in €	Pos.-No.	Price in €	Pos.-No.	Price in €
0/A	1,00-4,20	107A02		107A12			
0/B <small>(shaft 10,5)</small>	1,00-4,20	107C02		107C12			
0/B	4,21-7,40	107B02		107B12			
I	1,00-21,55	101112		103112		102112	
I/II	21,56-26,85	1012M2				1022M2	
II	21,56-28,25	101212		103212		102212	
	28,26-35,90	101222		103222		102222	
	35,91-42,40	101232		103232		102232	
	42,41-50,90	101242		103242		102242	
	50,91-53,90	101252		103252		102252	
III	53,91-74,25	101312				102312	
reinforced version	-21,55	108112		108312		108212	
	-28,25	108122		108322		108222	
	-53,90	1081-2		1083-2		1082-2	

Corner radius for square tools available on request. Surcharge: Punch +10%, Die +0%, Stripper +0%



Stripper

	Size	dim. „a“ in mm	machine group	Pos.-No.	Price in €
	II	-56,00	E / F / Boschert	110212	
		-56,00	A-D / G	111212	
		-56,00	H / I	112212	
	III	-77,00	Rota / Index	110212-1	
-77,00		C / D / Boschert	111312		
(I/II)	-30,00	S	1501M2		

Die

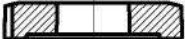
	Size	dim. „a“ in mm	HWS		HSS	
			Pos.-No.	Price in €	Pos.-No.	Price in €
	I	-22,50	106112		105112	
	I/II	-27,80	1061M2		1051M2	
	II	-54,90	106212		105212	
	III	-75,50	106312			
	reinforced version	-23,50	109112			
		-30,20	109222			
-43,00		109232				

Pricelist 09/06-T

Standard Tools
Rectangle

System

TRUMPF



BOSCHERT

GmbH&Co.KG

D-79523 Lörrach, Postfach 7042

Germany

Telefon + 49 7621 9593-0

Telefax + 49 7621 55184

<http://www.boschert.de>

e-mail: infoak@boschert.de

Punch

		HSS / Flat / 34,3 mm long		HSS / Flat / 37,8 mm long***		HSS / Whisper / 37,3 mm long	
Size	dim. „d“ in mm	Pos.-No.	Price in €	Pos.-No.	Price in €	Pos.-No.	Price in €
0/A	1,00-6,00	107A03		107A13			
0/B <small>(shaft 10,5)</small>	1,00-6,00	107C03		107C13			
0/B	6,01-10,50	107B03		107B13			
I	1,00-30,50	101113		103113		102113	
I/II	30,51-38,00	1012M3				1022M3	
II	30,51-40,00	101213		103213		102213	
	40,01-50,80	101223		103223		102223	
	50,81-60,00	101233		103233		102233	
	60,01-72,00	101243		103243		102243	
	72,01-76,20	101253		103253		102253	
III	76,21-105,00	101313				102313	
reinforced version	-30,50	108113		108313		108213	
	-40,00	108123		108323		108223	
	-76,20	1081-3		1083-3		1082-3	

Corner radius for rectangle tools available on request. Surcharge: Punch +10%, Die +0%, Stripper +0%

Pricelist 09/06-T

Standard Tools
Rectangle

System

TRUMPF



BOSCHERT

GmbH&Co.KG

D-79523 Lörrach, Postfach 7042

Germany

Telefon + 49 7621 9593-0

Telefax + 49 7621 55184

<http://www.boschert.de>

e-mail: infoak@boschert.de

Stripper

	Size	dim. „d“ in mm	machine group	Pos.-No.	Price in €
	II	-78,00	E / F / Boschert	110213	
		-78,00	A-D / G	111213	
		-78,00	H / I	112213	
	III	-107,00	Rota / Index	110213-1	
-107,00		C / D / Boschert	111313		
(I/II)	-41,00	S	1501M3		

Die

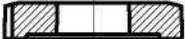
	Size	dim. „d“ in mm	HWS		HSS	
			Pos.-No.	Price in €	Pos.-No.	Price in €
	I	-32,00	106113		105113	
	I/II	-38,00	1061M3		1051M3	
	II	-77,00	106213		105213	
	III	-107,00	106313			
	reinforced version	-32,50	109113			
		-42,00	109223			
		-62,00	109233			

Pricelist 09/06-T

Standard Tools
Oblong

System

TRUMPF



BOSCHERT

GmbH&Co.KG

D-79523 Lörrach, Postfach 7042

Germany

Telefon + 49 7621 9593-0

Telefax + 49 7621 55184

<http://www.boschert.de>

e-mail: infoak@boschert.de

Punch

		HSS / Flat / 34,3 mm long		HSS / Flat / 37,8 mm long***		HSS / Whisper / 37,3 mm long	
Size	dim. „d“ in mm	Pos.-No.	Price in €	Pos.-No.	Price in €	Pos.-No.	Price in €
0/A	1,00-6,00	107A04		107A14			
0/B <small>(shaft 10,5)</small>	1,00-6,00	107C04		107C14			
0/B	6,01-10,50	107B04		107B14			
I	1,00-30,50	101114		103114		102114	
I/II	30,51-38,00	1012M4				1022M4	
II	30,51-40,00	101214		103214		102214	
	40,01-50,80	101224		103224		102224	
	50,81-60,00	101234		103234		102234	
	60,01-72,00	101244		103244		102244	
	72,01-76,20	101254		103254		102254	
III	76,21-105,00	101314				102314	
reinforced version	-30,50	108114		108314		108214	
	-40,00	108124		108324		108224	
	-76,20	1081-4		1083-4		1082-4	

Pricelist 09/06-T

Standard Tools
Oblong

System

TRUMPF



BOSCHERT

GmbH&Co.KG

D-79523 Lörrach, Postfach 7042

Germany

Telefon + 49 7621 9593-0

Telefax + 49 7621 55184

<http://www.boschert.de>

e-mail: infoak@boschert.de

Stripper

	Size	dim. „d“ in mm	machine group	Pos.-No.	Price in €
	II	-78,00	E / F / Boschert	110214	
		-78,00	A-D / G	111214	
		-78,00	H / I	112214	
	III	-107,00	Rota / Index	110214-1	
-107,00		C / D / Boschert	111314		
(I/II)	-41,00	S	1501M4		

Die

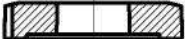
	Size	dim. „d“ in mm	HWS		HSS	
			Pos.-No.	Price in €	Pos.-No.	Price in €
	I	-32,00	106114		105114	
	I/II	-38,00	1061M4		1051M4	
	II	-77,00	106214		105214	
	III	-107,00	106314			
	reinforced version	-32,50	109114			
		-42,00	109224			
-62,00		109234				

Pricelist 09/06-T

Special Shape Tool

Group 1

(SF01, SF02, SF04, SF05)

System

TRUMPF



BOSCHERT

GmbH&Co.KG

D-79523 Lörrach, Postfach 7042

Germany





Telefon + 49 7621 9593-0

Telefax + 49 7621 55184

<http://www.boschert.de>

e-mail: infoak@boschert.de

Punch

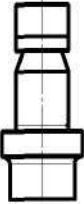
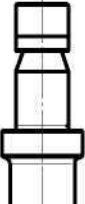
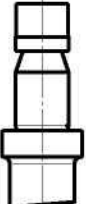
		HSS / Flat / 34,3 mm long		HSS / Flat / 37,8 mm long***		HSS / Whisper / 37,3 mm long	
SF 01  SF 02  SF 04  SF 05  to complete part.-no.							
Size	dim. „d“ in mm	Pos.-No.	Price in €	Pos.-No.	Price in €	Pos.-No.	Price in €
0/A	1,00-6,00	121A0..		123A0..			
0/B <small>(shaft 10,5)</small>	1,00-6,00	121C0..		123C0..			
0/B	6,01-10,50	121B0..		123B0..			
I	1,00-30,50	12111..		12311..		12211..	
I/II	30,51-38,00	121M1..				122M1..	
II	30,51-40,00	12121..		12321..		12221..	
	40,01-50,80	12122..		12322..		12222..	
	50,81-60,00	12123..		12323..		12223..	
	60,01-72,00	12124..		12324..		12224..	
	72,01-76,20	12125..		12325..		12225..	
III	76,21-105,00	12131..				12231..	
reinforced version	-30,50	V2111..		V2311..		V2211..	
	-40,00	121V1..		123V1..		122V1..	
	-76,20	121V5..		123V5..		122V5..	



Stripper

	Size	dim. „d“ in mm	machine group	Pos.-No.	Price in €
	II	-78,00	E / F / Boschert	12721..	
		-78,00	A-D / G	127D1..	
		-78,00	H / I	127H1..	
	III	-107,00	Rota / Index	12731-1..	
-107,00		C / D / Boschert	1273D..		
(I/II)	-41,00	S	127M1..		

Die

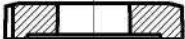
	Size	dim. „d“ in mm	HWS		HSS	
			Pos.-No.	Price in €	Pos.-No.	Price in €
	I	-32,00	12611..		12511..	
	I/II	-38,00	126M1..		125M1..	
	II	-77,00	12621..		12521..	
	III	-107,00	12631..			
	reinforced version	-32,50	V2611..			
		-42,00	126V1..			
-62,00		126V2..				

SF 01

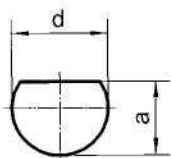

SF 02

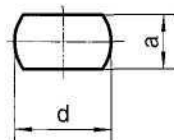

SF 04

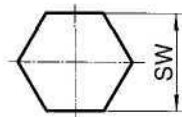

SF 05

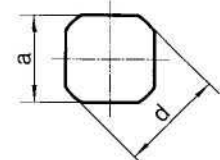

Pricelist 09/06-T
Special Shape Tools
Group 2
(SF03, SF07, SF13, SF17)

System

TRUMPF



BOSCHERT

GmbH&Co.KG

D-79523 Lörrach, Postfach 7042

Germany





Telefon + 49 7621 9593-0

Telefax + 49 7621 55184

<http://www.boschert.de>

e-mail: infoak@boschert.de

Punch

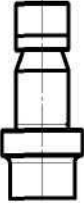
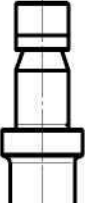
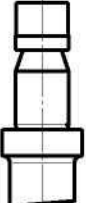
		HSS / Flat / 34,3 mm long		HSS / Flat / 37,8 mm long***		HSS / Whisper / 37,3 mm long	
SF 03  SF 07  SF 13  SF 17  to complete part.-no.							
Size	dim. „d“ in mm	Pos.-No.	Price in €	Pos.-No.	Price in €	Pos.-No.	Price in €
0/A	1,00-6,00	121A0..		123A0..			
0/B <small>(shaft 10,5)</small>	1,00-6,00	121C0..		123C0..			
0/B	6,01-10,50	121B0..		123B0..			
I	1,00-30,50	12111..		12311..		12211..	
I/II	30,51-38,00	121M1..				122M1..	
II	30,51-40,00	12121..		12321..		12221..	
	40,01-50,80	12122..		12322..		12222..	
	50,81-60,00	12123..		12323..		12223..	
	60,01-72,00	12124..		12324..		12224..	
	72,01-76,20	12125..		12325..		12225..	
III	76,21-105,00	12131..				12231..	
reinforced version	-30,50	V2111..		V2311..		V2211..	
	-40,00	121V1..		123V1..		122V1..	
	-76,20	121V5..		123V5..		122V5..	

Pricelist 09/06-T
 Special Shape Tools
 Groupe 2
 (SF03, SF07, SF13, SF17)

System

TRUMPF



BOSCHERT

GmbH&Co.KG

D-79523 Lörrach, Postfach 7042

Germany

Telefon + 49 7621 9593-0

Telefax + 49 7621 55184

<http://www.boschert.de>

e-mail: infoak@boschert.de

Stripper

	Size	dim. „d“ in mm	machine group	Pos.-No.	Price in €	
	II	-78,00	-78,00	E / F / Boschert	12721..	
		-78,00	-78,00	A-D / G	127D1..	
		-78,00	-78,00	H / I	127H1..	
	III	-107,00	-107,00	Rota / Index	12731-1..	
-107,00		-107,00	C / D / Boschert	1273D..		
(I/II)	-41,00	-41,00	S	127M1..		

Die

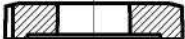
	Size	dim. „d“ in mm	HWS		HSS	
			Pos.-No.	Price in €	Pos.-No.	Price in €
	I	-32,00	12611..		12511..	
	I/II	-38,00	126M1..		125M1..	
	II	-77,00	12621..		12521..	
	III	-107,00	12631..			
	reinforced version	-32,50	V2611..			
		-42,00	126V1..			
-62,00		126V2..				

SF 03

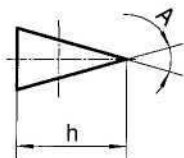

SF 07

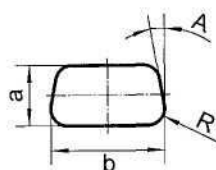

SF 13

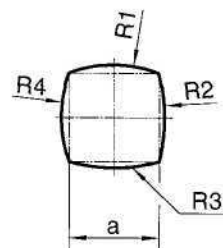

SF 17

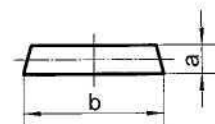

Pricelist 09/06-T
 Special Shape Tools
 Group 3
 (SF06, SF08, SF14, SF16)

System

TRUMPF



BOSCHERT

GmbH&Co.KG

D-79523 Lörrach, Postfach 7042

Germany





Telefon + 49 7621 9593-0

Telefax + 49 7621 55184

<http://www.boschert.de>

e-mail: infoak@boschert.de

Punch

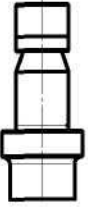
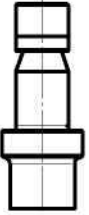
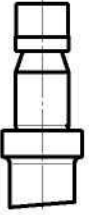
		HSS / Flat/ 34,3 mm long		HSS / Flat/ 37,8 mm long***		HSS / Whisper / 37,3 mm long	
SF 06  SF 08  SF 14  SF 16  to complete part.-no.							
Size	dim. „d“ in mm	Pos.-No.	Price in €	Pos.-No.	Price in €	Pos.-No.	Price in €
0/A	1,00-6,00	121A0..		123A0..			
0/B <small>(shaft 10,5)</small>	1,00-6,00	121C0..		123C0..			
0/B	6,01-10,50	121B0..		123B0..			
I	1,00-30,50	12111..		12311..		12211..	
I/II	30,51-38,00	121M1..				122M1..	
II	30,51-40,00	12121..		12321..		12221..	
	40,01-50,80	12122..		12322..		12222..	
	50,81-60,00	12123..		12323..		12223..	
	60,01-72,00	12124..		12324..		12224..	
	72,01-76,20	12125..		12325..		12225..	
III	76,21-105,00	12131..				12231..	
reinforced version	-30,50	V2111..		V2311..		V2211..	
	-40,00	121V1..		123V1..		122V1..	
	-76,20	121V5..		123V5..		122V5..	



Stripper

	Size	dim. „d“ in mm	machine group	Pos.-No.	Price in €
	II	-78,00	E / F / Boschert	12721..	
		-78,00	A-D / G	127D1..	
		-78,00	H / I	127H1..	
	III	-107,00	Rota / Index	12731-1..	
-107,00		C / D / Boschert	1273D..		
(I/II)	-41,00	S	127M1..		

Die

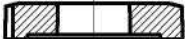
	Size	dim. „d“ in mm	HWS		HSS	
			Pos.-No.	Price in €	Pos.-No.	Price in €
	I	-32,00	12611..		12511..	
	I/II	-38,00	126M1..		125M1..	
	II	-77,00	12621..		12521..	
	III	-107,00	12631..			
	reinforced version	-32,50	V2611..			
		-42,00	126V1..			
		-62,00	126V2..			

SF 06

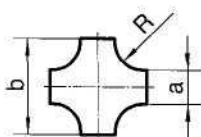

SF 08

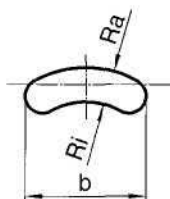

SF 14

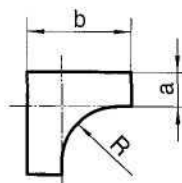

SF 16

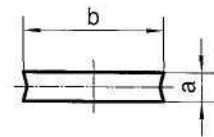

Pricelist 09/06-T

Special Shape Tools

Group 4

(SF09, SF10, SF11, SF12, SF15)

System

TRUMPF



BOSCHERT

GmbH&Co.KG

D-79523 Lörrach, Postfach 7042

Germany

Telefon + 49 7621 9593-0

Telefax + 49 7621 55184

<http://www.boschert.de>

e-mail: infoak@boschert.de

Punch							
		HSS / Flat / 34,3 mm long		HSS / Flat / 37,8 mm long***		HSS / Whisper / 37,3 mm long	
SF 09							
SF 10							
SF 11							
SF 12							
SF 15							
to complete part.-no.							
Size	dim. „d“ in mm	Pos.-No.	Price in €	Pos.-No.	Price in €	Pos.-No.	Price in €
0/A	1,00-6,00	121A0..		123A0..			
0/B <small>(shaft 10,5)</small>	1,00-6,00	121C0..		123C0..			
0/B	6,01-10,50	121B0..		123B0..			
I	1,00-30,50	12111..		12311..		12211..	
I/ II	30,51-38,00	121M1..				122M1..	
II	30,51-40,00	12121..		12321..		12221..	
	40,01-50,80	12122..		12322..		12222..	
	50,81-60,00	12123..		12323..		12223..	
	60,01-72,00	12124..		12324..		12224..	
	72,01-76,20	12125..		12325..		12225..	
III	76,21-105,00	12131..				12231..	
reinforced version	-30,50	V2111..		V2311..		V2211..	
	-40,00	121V1..		123V1..		122V1..	
	-76,20	121V5..		123V5..		122V5..	



Stripper

	Size	dim. „d“ in mm	machine group	Pos.-No.	Price in €	
	II	-78,00	-78,00	E / F / Boschert	12721..	
		-78,00	-78,00	A-D / G	127D1..	
		-78,00	-78,00	H / I	127H1..	
	III	-107,00	-107,00	Rota / Index	12731-1..	
-107,00		-107,00	C / D / Boschert	1273D..		
(I/II)	-41,00	-41,00	S	127M1..		

Die

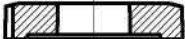
	Size	dim. „d“ in mm	HWS		HSS	
			Pos.-No.	Price in €	Pos.-No.	Price in €
	I	-32,00	12611..		12511..	
	I/II	-38,00	126M1..		125M1..	
	II	-77,00	12621..		12521..	
	III	-107,00	12631..			
	reinforced version	-32,50	V2611..			
		-42,00	126V1..			
		-62,00	126V2..			

SF 09

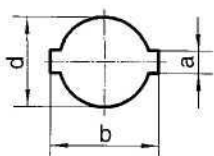

SF 10

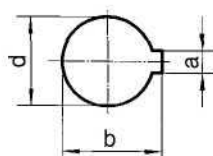

SF 11

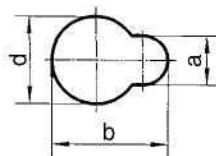

SF 12

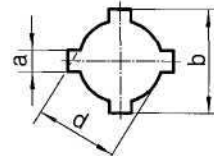

SF 15

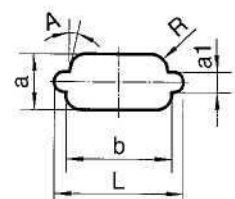

* Also for machine group „S“

** Only for machine group „S“



**PU - Stripper
to presser for your form**

	part.-no.	Price in €
for punches - Ø 6 mm (outside Ø 20 mm)	30110001	
for punches - Ø 10,5 mm (outside Ø 30 mm)	30110002	
for punches - Ø 20 mm (outside Ø 40 mm)	30110003	
for punches - Ø 25 mm (outside Ø 50 mm)	30110004	
for punches Ø 30 mm (outside Ø 60 mm)	30110005	
for punches - Ø 40 mm (outside Ø 70 mm)	301100027	
for punches Ø 50 mm (outside Ø 80 mm)	30110006	

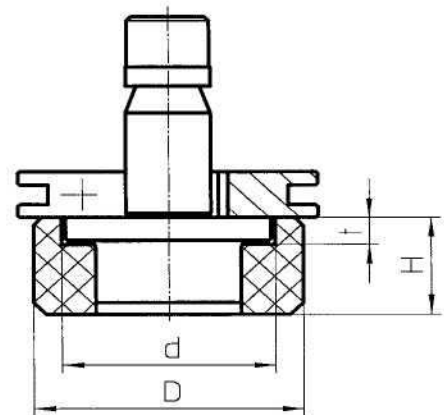
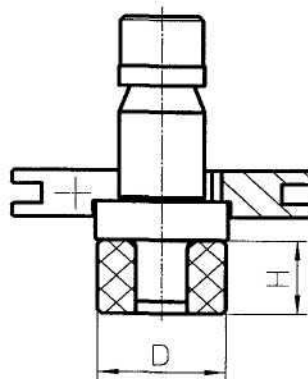

Used for:

- noise reduction
- punching close to forming

Caution:

Severe wearing of the polyurethane springs may result when they are in contact with punched holes or sheet edges.

Pricelist 09/06-T

Revotool

System

TRUMPF



BOSCHERT

GmbH&Co.KG

D-79523 Lörrach, Postfach 7042

Germany

Telefon + 49 7621 95 93-0

Telefax + 49 7621 55 184

<http://www.boschert.de>

e-mail: infoak@boschert.de

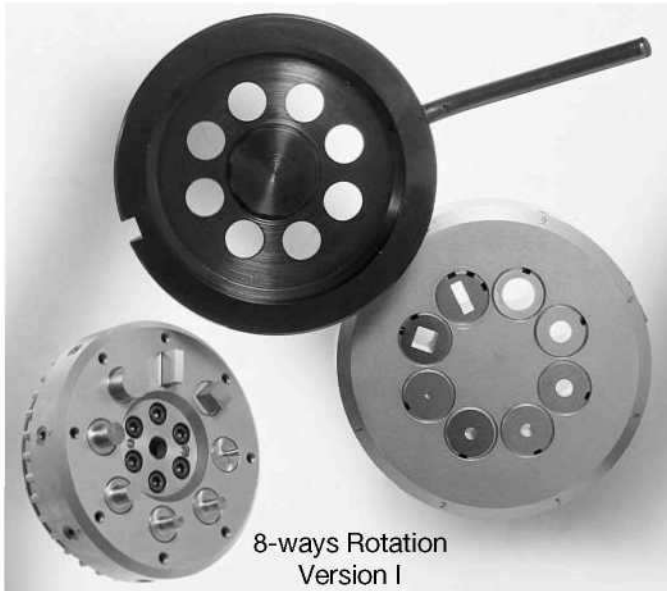

8-ways Rotation
Version I



INDEX

description	4-ways/6mm Revotool INDEX dim. – 25,0 mm	6-ways/6mm Revotool INDEX dim. – 20,0 mm	8-ways/6mm Revotool INDEX dim. – 16,0 mm	8-ways Revotool Version I dim. – 16,0 mm
Punch round	part.-no. 30006031	part.-no. 30006041	part.-no. 30006021	part.-no. 30006001
Die round	part.-no. 30006032	part.-no. 30006042	part.-no. 30006022	part.-no. 30006002
Punch square	part.-no. 30006033	part.-no. 30006043	part.-no. 30006023	part.-no. 30006003
Die square	part.-no. 30006034	part.-no. 30006044	part.-no. 30006024	part.-no. 30006004
Punch oblong	part.-no. 30006035	part.-no. 30006045	part.-no. 30006025	part.-no. 30006005
Die oblong	part.-no. 30006036	part.-no. 30006046	part.-no. 30006026	part.-no. 30006006
Punch rectangle	part.-no. 30006037	part.-no. 30006047	part.-no. 30006027	part.-no. 30006007
Die rectangle	part.-no. 30006038	part.-no. 30006048	part.-no. 30006028	part.-no. 30006008
Punch special shape	on request	on request	on request	on request
Die special shape	on request	on request	on request	on request
Revotool-Holder : Punch holder, Die holder (without toolings)				
	part.-no. 30006039	part.-no. 30006049	part.-no. 30006020	

Pricelist 09/06-T
Spare Parts for Revotool

System
TRUMPF



BOSCHERT

GmbH&Co.KG

D-79523 Lörrach, Postfach 7042

Germany

Telefon + 49 7621 9593-0

Telefax + 49 7621 55184

<http://www.boschert.de>

e-mail: infoak@boschert.de

Spare Parts Revotool 8-ways / 6 mm + Rotation	Price in €
Set of springs compl. (8 x kl. / 1 x gr.)	
Locking Pin	
Centre Pivot	
Stripper	
Distance Ring	
Stripper Pivot	
Gear	
Golden Ring	



Spare Parts Revotool 6-ways / 6 mm	Price in €
Set of springs compl. (6 x kl. / 1 x gr.)	
Locking Pin	
Centre Pivot	
Stripper	
Distance Ring	
Stripper Pivot	
Gear	
Golden Ring	



Spare Parts Revotool 4-ways / 6 mm	Price in €
Set of springs compl. (4 x grl. / 7 x kl. / 1 x gr.)	
Locking Pin	
Centre Pivot	
Stripper	
Distance Ring	
Stripper Pivot	
Gear	
Golden Ring	



Pricelist 09/06-T
Spare Parts for Revotool
7-ways

System
TRUMPF



BOSCHERT

GmbH&Co.KG

D-79523 Lörrach, Postfach 7042

Germany

Telefon + 49 7621 9593-0

Telefax + 49 7621 55184

<http://www.boschert.de>

e-mail: infoak@boschert.de

Spare Parts Revotool 7-ways / 6 mm	Price in €
Set of springs compl. (7 x kl. / 1 x gr.)	
Locking Pin	
Centre Pivot	
Stripper	
Distance Ring	
Stripper Pivot	
Gear	
Golden Ring	



Option: available for all Revotools you can have suitable contour stripper for thin material < 1 mm. Price on request.

Beschreibung	7-ways/6 mm Revotool dim. - 16,0 mm
---------------------	--

Punch round	part.-no. 30006084
Die round	part.-no. 30006085

Punch square	part.-no. 30006086
Die square	part.-no. 30006087

Punch oblong	part.-no. 30006088
Die oblong	part.-no. 30006089

Punch rectangle	part.-no. 30006090
Die rectangle	part.-no. 30006091

Punch special shape	on request
Die special shape	on request

Slitting punch 5 x 30 rectangle	part.-no. 30006082
---	--------------------

Slitting punch Holder with Blade	on request
---	------------

Slitting Die 7-ways 5 x 30 rectangle	part.-no. 30006083
--	--------------------

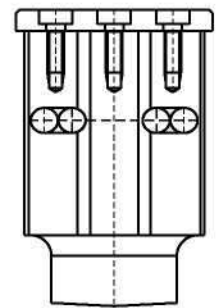

Revotool-Holder	
Punch holder, Die holder (without toolings)	part.-no. 30006080

Pricelist 09/06-T

Fully guided
round punch
assemblies
to dim. 10,5 mm
System

TRUMPF



BOSCHERT

GmbH&Co.KG

D-79523 Lörrach, Postfach 7042

Germany

Telefon + 49 7621 9593-0

Telefax + 49 7621 55184

<http://www.boschert.de>

e-mail: infoak@boschert.de

Fully guided ROUND punch assemblies to dm 10,5 mm (without Die)

description	dim. „d“ in mm	Pos.-No.	Price in €	
complete upper part	0,50-6,00	1S160A		
complete upper part	6,01-10,50	1S160B		

Spare parts for fully guided round punches

description	dim. „d“ in mm	Pos.-No.	Price in €	
punch insert / ASP 23	0,50-6,00	1S16SA		
punch insert / ASP 23	6,01-10,50	1S16SB		
spring	0,50-6,00	1S1608		
spring	6,01-10,50	1S1609		
guide	0,50-6,00	1S1603		
guide	6,01-10,50	1S1604		
lock nut	0,50-10,50	1S1607		

Pricelist 09/06-T

Fully guide shape punches assemblies for shapes that fit within diam. = 16 mm

System

TRUMPF



BOSCHERT

GmbH&Co.KG

D-79523 Lörrach, Postfach 7042

Germany

Telefon + 49 7621 9593-0

Telefax + 49 7621 55184

<http://www.boschert.de>

e-mail: infoak@boschert.de

Fully guided SHAPE punches assemblies for shapes that fit within Dim. 16 mm circle (without Die)

shape	Pos.-No.	Price in €
square	1S16502	
rectangular	1S16503	
oblong	1S16504	
special shape	1S16500	

Spare punch(C101653) ASP 23

shape	Pos.-No.	Price in €
square	1S16532	
rectangular	1S16533	
oblong	1S16534	
special shape	1S16530	

Spare guide (C101656)

shape	Pos.-No.	Price in €
square	1S16562	
rectangular	1S16563	
oblong	1S16564	
special shape	1S16560	

Spare spring (C101654)

shape	Pos.-No.	Price in €
usable for all shapes	1S16540	

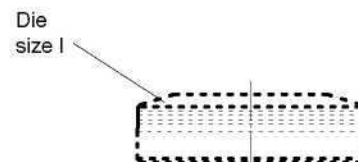
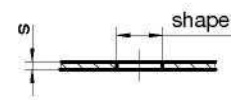
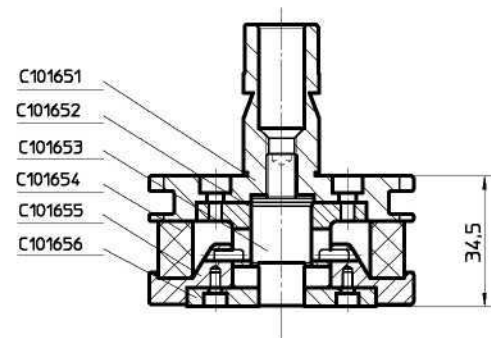

Pricelist 09/06-T

Adjusting Rings and Accessories

System

TRUMPF



BOSCHERT

GmbH&Co.KG

D-79523 Lörrach, Postfach 7042

Germany

Telefon + 49 7621 9593-0

Telefax + 49 7621 55184

<http://www.boschert.de>

e-mail: infoak@boschert.de

Adjusting ring incl. key fo automatic tool changers

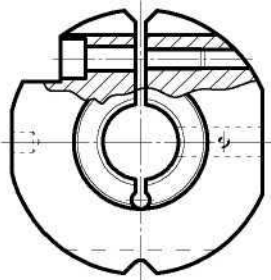
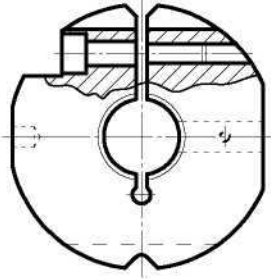
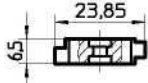
		Size	machine group	Pos.-No.	Price in €
	Adjusting ring incl. bolt	I	E-I	118101	
	Adjusting ring incl. bolt	II/III	E-I	118201	
	Adjusting key		E-I	118902	

Adjusting ring incl. key for reinforced version punches

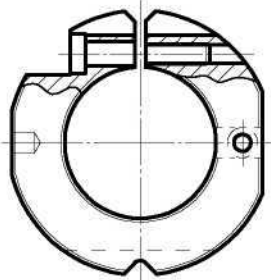
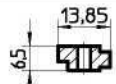
		Size	machine group	Pos.-No.	Price in €
	Adjusting ring incl. bolt	I/II	A-I Boschert	118V01	
	Adjusting key		A-I Boschert	118903	

Pricelist 09/06-T

Adjusting Rings and Accessories

System

TRUMPF



BOSCHERT

GmbH&Co.KG

D-79523 Lörrach, Postfach 7042

Germany

Telefon + 49 7621 9593-0

Telefax + 49 7621 55184

<http://www.boschert.de>

e-mail: infoak@boschert.de

Adjusting ring incl. bolt for manual tool change

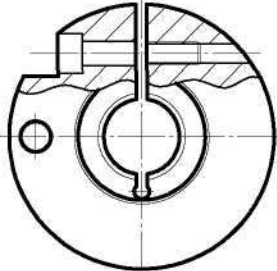
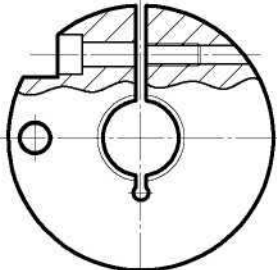
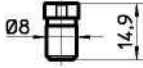
		Size	machine group	Pos.-No.	Price in €
	Adjusting ring incl. bolt	I	A-D Boschert	118102	
	Adjusting ring incl. bolt	II/III	A-D Boschert	118202	
	Adjusting ring incl. bolt	III	A-D Boschert	118302	
	Adjusting ring incl. bolt outside Ø 95				
	Adjusting bolt		A-D Boschert	118901	

Adjusting ring incl. key for automatic tool changers

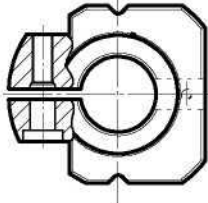
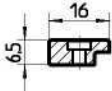
		Size	machine group	Pos.-No.	Price in €
	Adjusting ring incl. key	I	S	11820M	
	Adjusting ring incl. key	II	S	11810M	
	Adjusting key		S	118904	

Pricelist 09/06-T

Anti-Twist-Lock
System - Pass-Fit

System

TRUMPF



BOSCHERT

GmbH&Co.KG

D-79523 Lörrach, Postfach 7042

Germany

Telefon + 49 7621 9593-0

Telefax + 49 7621 55184

<http://www.boschert.de>

e-mail: infoak@boschert.de

Special version: Pass-Fit-System

- for use as form-fitting anti - twist - lock
- for quick adjustment without the need for special tools
- keyways per customer request
- BOSCHERT-Forming tools and cluster tools are generally manufactured with PASS-FIT system

Gr I	Gr II/III
part. - no.	
pass-fit-1*	pass-fit-2*
additional charge in € for punch	
first slot each additional slot	1 boring incl. pin (pos.: 0° + 90°) each additional boring
additional charge in € for adjustment rings	
automatic , manual	automatic, manuel

Pricelist 09/06-T

Punch Chucks and Adapter Rings

System

TRUMPF



BOSCHERT

GmbH&Co.KG

D-79523 Lörrach, Postfach 7042

Germany

Telefon + 49 7621 9593-0

Telefax + 49 7621 55184

<http://www.boschert.de>

e-mail: infoak@boschert.de

Punch Chuck

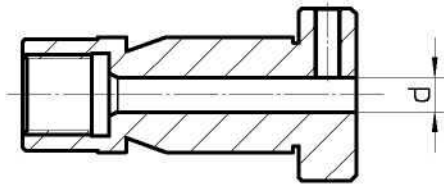

Size	dim. „d“	Pos.-No.	Price in €
0 A	- 6,00 mm	119A01	
0 B	- 10,50 mm	119B01	

Adapter rings for strippers

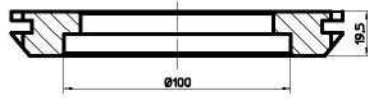

Size	machine group	Pos.-No.	Price in €
III/II	G	120321	

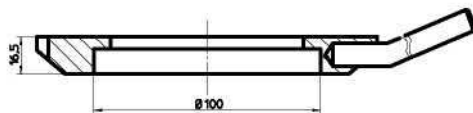

III/II	Trumpf C/D and Boschert machine group	120326 with slots	
--------	---	----------------------	--

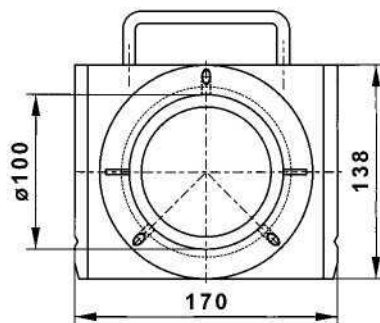

III/II	Rotation Up to modele 2002	120326-1	
--------	-------------------------------	----------	--

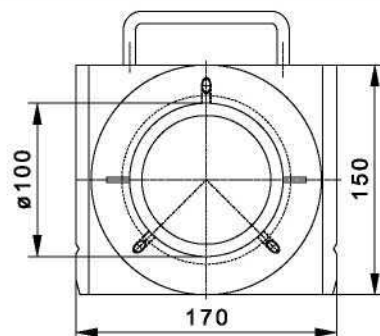

III/II	INDEX Frome 2003	120326-3	
--------	---------------------	----------	--



Adapter rings for dies

	Size	machine group	Pos.-No.	Price in €
	II/I	A, B, F, G, H, I + LB 13 Quick	120210	
	III/I	G Boschert- Rota / Index	120310	
	III/II	G Boschert- Rota / Index	120320	
	III/I	Boschert machine group without Rotation	1203310-1	
	III/II	Boschert machine group without Rotation	1203310-2	

Pricelist 09/06-T

Rotary
Die Adapter

System

TRUMPF



BOSCHERT

GmbH&Co.KG

D-79523 Lörrach, Postfach 7042

Germany

Telefon + 49 7621 9593-0

Telefax + 49 7621 55184

<http://www.boschert.de>

e-mail: infoak@boschert.de

Rotary die adapter from size II to size I

Size	Pos.-No.	Price in €	
reduced from Size II to I	1S1900		

Rotary die adapter from size III to II

Size	Pos.-No.	Price in €	
reduced from Size III to II	1S1950		